

Understanding Schematics

And Electrical Troubleshooting

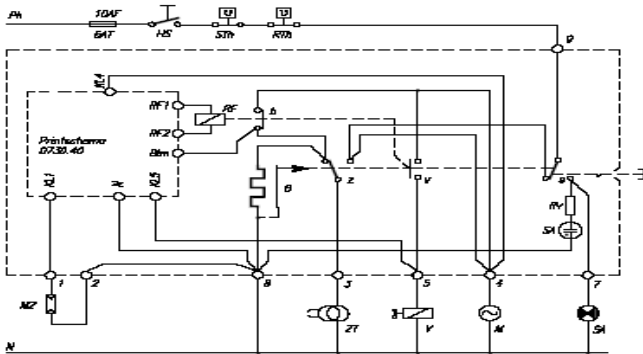

- *Electrical symbols*
- *Schematics VS ladder diagrams*
- *Schematics and troubleshooting*

Instructor: Dave Hartwell

When: Tuesday, 7-16-19, 12:30 – 3:30 PM

Where: F. W. Webb

1 McCrea Hill Rd., Ballston Spa

Tuition: \$25.00

Register online @ <http://eseany.org/training.php>

For more info call Oilheat Associates @ 516-679-4686